



escodisc

DMU

SERIES DMU

The General Purpose High Torque/High Misalignment Solution

Maximum torque capacity: up to 260000 Nm - Bore Capacity: up to 370 mm

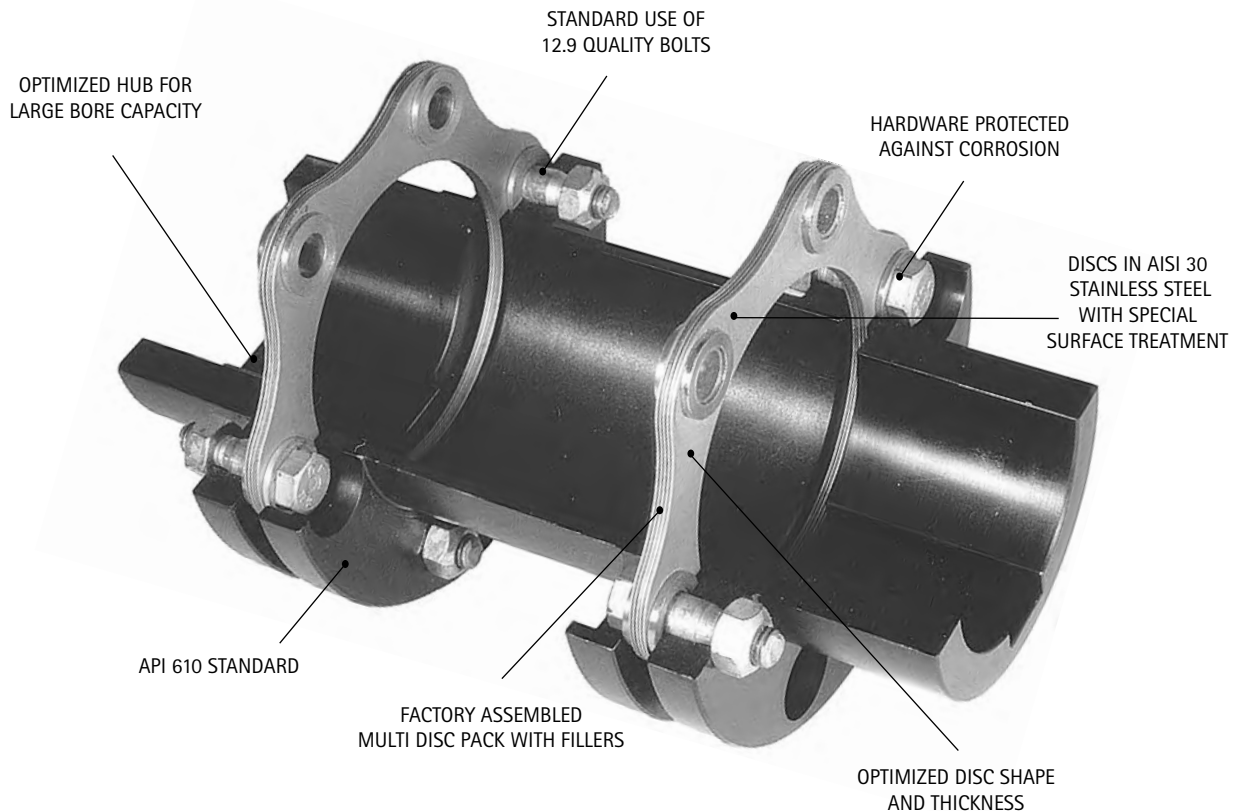

General Purpose Design

Because of the high torque, bore and misalignment capacity of the Escodisc DMU coupling range, its high degree of natural inherent balance (AGMA class 9) up to size 85 and the fact that it meets the API 610 standards, this coupling is the ideal solution in a multitude of applications up to 260000 Nm (and larger upon request).

Unitised Disc Pack

The DMU disc pack consists of an optimised number of discs or separated links (for sizes greater or equal to size 190) and has been factory assembled for easy field assembly. To eliminate fretting corrosion (which limits disc type coupling life), stainless steel fillers between the discs are used.

Close Coupled Design

The Escodisc DMU coupling is also available in close coupled design (DMUCC). The high torque/bore capacity makes it an ideal maintenance free alternative for close coupled gear and elastic type couplings and can be modified in such a way that replacement of gear and elastic couplings is possible without modifications to an existing installation. Furthermore, thanks to the split spacer design, disconnection of the two machines and replacement of the disc pack is possible without axial displacement of the connected machines.



escodisc

DMU

Escodisc Series DMU - Quick Selection Table

Coupling size	Maximum Power (kW)															Max. Speed (Rpm)	Max. Bore (mm)
	1000 Rpm			1500 Rpm			1800 Rpm			3000 Rpm			3600 Rpm				
	SF 1	SF 1,5	SF 2	SF 1	SF 1,5	SF2	SF 1	SF 1,5	SF2	SF 1	SF 1,5	SF2	SF 1	SF 1,5	SF2		
DMU 38-45	20	13	10	30	20	15	36	24	18	60	40	30	72	48	36	16000	45
DMU 45-55	35	23	17	52	35	26	62	41	31	104	69	52	124	83	62	13600	55
DMU 55-65	79	52	39	118	79	59	141	94	71	236	157	118	283	188	141	12000	65
DMU 65-75	139	93	70	209	139	104	251	167	125	418	279	209	501	334	251	10000	75
DMU 75-90	230	154	115	346	230	173	415	276	207	691	461	346	829	553	415	8600	90
DMU 85-105	366	244	183	550	366	275	660	440	330	1099	733	550	1319	880	660	7200	105
DMU 95-105	586	391	293	880	586	440	1056	704	528	1759	1173	880	2111	1407	1056	6400	105
DMU 110-120	838	558	419	1257	838	628	1508	1005	754	2513	1675	1257	3016	2010	1508	5600	120
DMU 125-135	1141	761	571	1712	1141	856	2054	1370	1027	3424	2283	1712	4109	2739	2054	5000	135
DMU 140-160	1487	991	744	2231	1487	1115	2677	1784	1338	4461	2974	2231	5353	3569	2677	4600	160
DMU 160-185	2074	1383	1037	3109	2073	1554	3735	2490	1868	6226	4151	3113	11245	7497	5623	4000	185

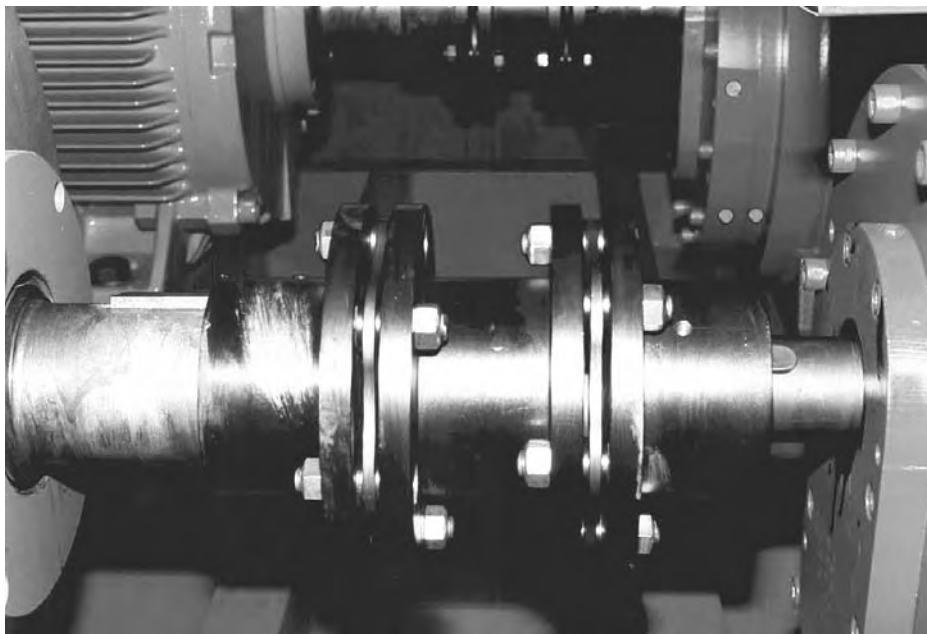



escodisc

DMU 38-45 ⇨ 160-185

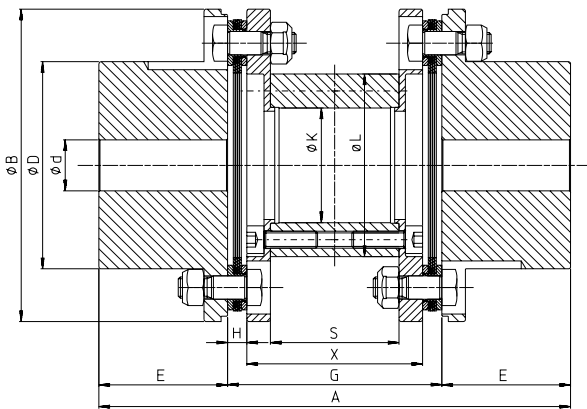

Size 38 -45 to 85 -105

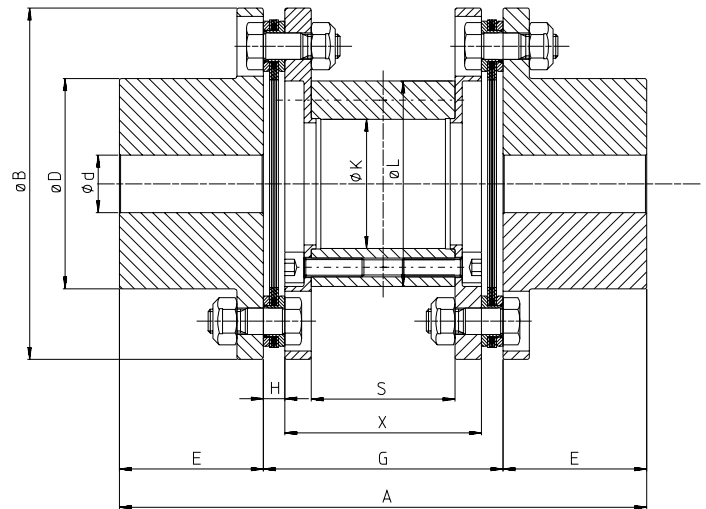

Size 95 -105 to 160 -185

←A105			Type DMU											
			38-45	45-55	55-65	65-75	75-90	85-105	95-105	110-120	125-135	140-160	160-185	
	1	mm	Ø max.	45	55	65	75	90	105	105	120	135	160	185
			Ø min.	0	0	0	25	32	38	45	55	65	65	80
	2.1	Nm	Tn	190	330	750	1330	2200	3500	5600	8000	10900	14200	19800
			Tp	290	500	1120	2000	3320	5200	8400	12000	16400	21200	29600
	3	tr/min omw/min rpm min ⁻¹	min.max.	8000	6800	6000	5000	4300	3600	3200	2800	2500	2300	2000
				16000*	13600*	12000*	10000*	8600*	7200*	6400*	5600*	5000*	4600*	4000*
	12	degré graad degree Grad		2x0,75	2x0,5	2x0,5	2x0,5	2x0,5	2x0,5	2x0,5	2x0,5	2x0,5	2x0,5	2x0,5
	12	mm: ±	ΔKa	2,4	2	2,4	2,6	3	4	4	4,4	5,2	6,6	6,8
	12	mm: ±	ΔKr	0,8	0,8	0,8	0,8	1,1	1,1	1,1	1,4	1,4	2	2
	4	kgm ²	J (WR ²)	0,0015	0,004	0,008	0,018	0,04	0,084	0,136	0,262	0,434	0,779	1,436
	5	kg		3,08	4,98	8	12,05	20,12	30,65	39,5	59,8	79,04	115,5	163,6
mm ±	A	11	mm	170	190	200	220	280	310	330	400	430	530	570
	B		mm	88	102	123	147	166	192	224	244	273	303	340
	D		mm	58,5	69,5	82	97,5	113	132	133	154	175	196	228
	E		mm	35	45	50	60	70	85	95	110	125	140	160
	G	11•	mm	100	100	100	100	140	140	140	180	180	250	250
	H		mm	6,7	6,5	7	9	10	13	14	15,5	19	20	20
	K		mm	21	37	48	54	65	76	94	108	123	143	165
	L		mm	41	61	72	86	98	116	134	156	171	191	221
	S	11	mm	70,6	71	64	60	88	80	76	103	96	160	154
	X		mm	86,6	87	86	82	120	114	112	149	142	210	210

* Balancing needed – • Other lenght available – Please consult us.



DMU 190-220 ⇨ 360-370

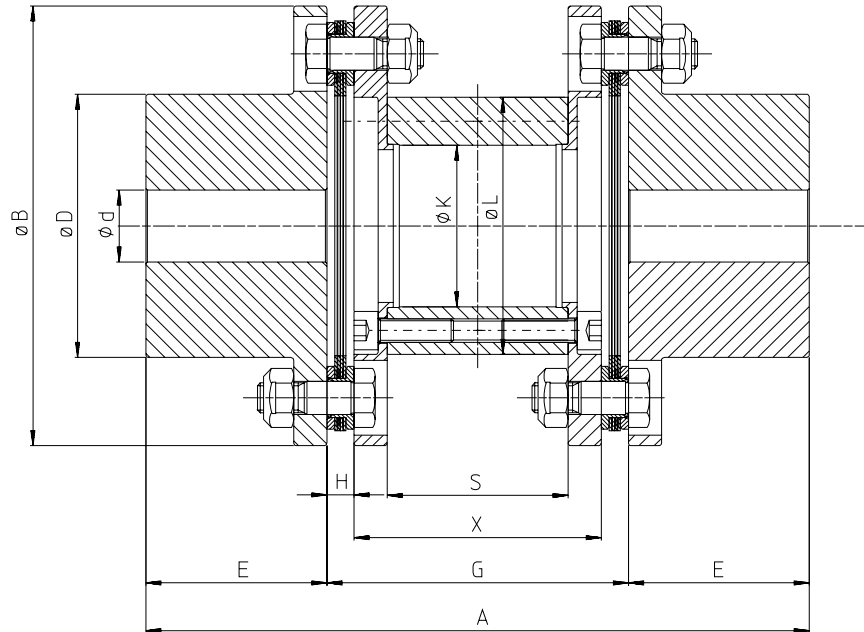

←A105			Type DMU						
			190-220	220-255	250-290	280-320	320-360	360-370	
d	1	mm	220	255	290	320	360	370	
		mm	90	120	150	180	200	200	
Tn 1m T _p	2.1	Nm	30700	53000	93000	120000	167000	260000	
		Nm	46000	80000	140000	180000	250000	390000	
/min.max.	3	tr/min omw/min rpm min ⁻¹	1800	1500	1300	1200	1050	900	
ΔK _w	12	degré graad degree Grad	2x0,33	2x0,33	2x0,25	2x0,25	2x0,2	2x0,2	
ΔK _a	12	mm: ±	5	6,6	7,6	8	9	6	
ΔK _r	12	mm: ±	1,4	1,6	1,3	1,4	1,3	1,4	
J (WR ²)	4	kgm ²	3	7,3	11,6	23	36	72	
	5	kg	222	358	418	680	916	1400	
mm ±	A	11	mm	630	720	800	900	1020	1120
	B		mm	368	445	515	554	604	704
	D		mm	266	320	350	392	431	504
	E		mm	190	220	250	280	320	360
	G		mm	250	280	300	340	380	400
	H		mm	19,25	24,6	38	41	44,9	34
	K		mm	204	254	292	314	330	432
	L		mm	268	318	364	394	426	528
	S		mm	165,5	174,8	160	186	217,2	252
	X		mm	211,5	230,8	224	258	290,2	332



escodisc

DMUCC 45-45 ⇨ 160-170

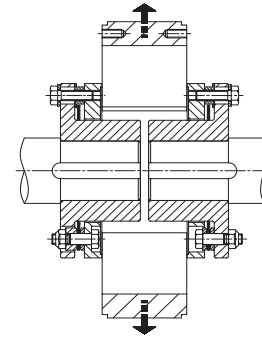
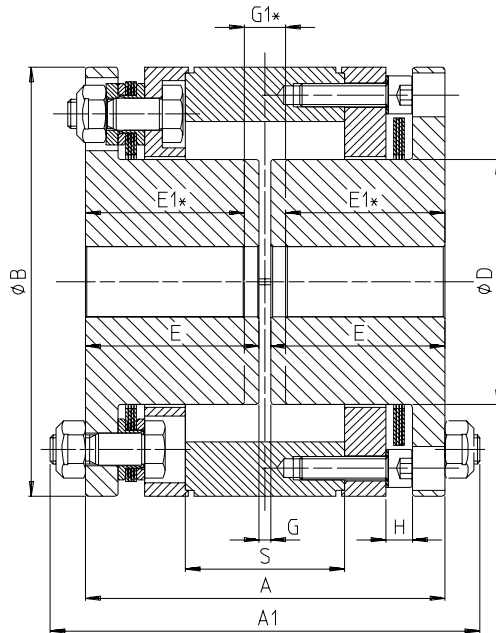

Split spacer





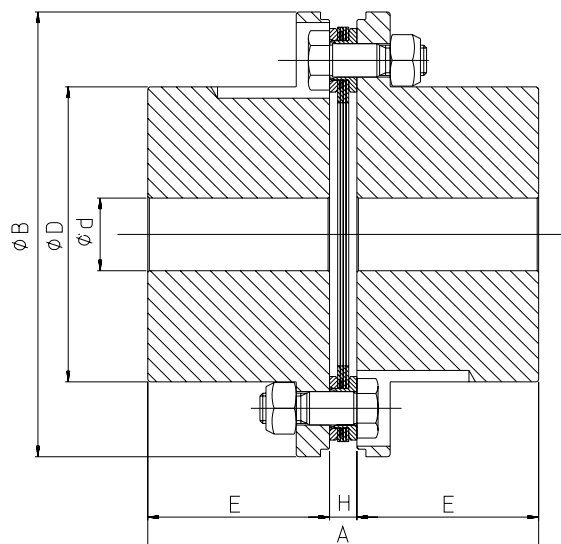

← A105			Type DMUCC										
			45-45	55-50	65-65	75-75	85-90	95-95	110-115	125-130	140-140	160-170	
	d	∅ max.	45	50	65	75	90	95	115	130	140	170	
		∅ min.	0	0	25	32	38	45	55	65	65	80	
	1m	Tn	330	750	1330	2200	3500	5600	8000	10900	14200	19800	
		Tp	500	1120	2000	3320	5200	8400	12000	16400	21200	29600	
	3	tr/min	6800	6000	5000	4300	3600	3200	2800	2500	2300	2000	
min.max.		omw/min rpm min ⁻¹											
	12	∆K _W	2x0,5	2x0,5	2x0,5	2x0,5	2x0,5	2x0,5	2x0,5	2x0,5	2x0,5	2x0,5	
∆K _W		degré graad degree Grad											
	12	∆K _a	2	2,4	2,6	3	4	4	4,4	5,2	6,6	6,8	
∆K _a		mm: ±											
	12	∆K _r	0,8	0,8	0,8	0,8	1,1	1,1	1,4	1,4	2	2	
∆K _r		mm: ±											
	4	J (WR ²)	0,006	0,014	0,032	0,062	0,135	0,272	0,459	0,8	1,36	2,5	
J		kgm ²											
	5	Weight	4,52	7,57	12,01	17,42	29,08	42,7	61,2	84,3	118	170	
Weight		kg											
mm ±	A	11	mm	93	103	122	132	174	194	226	256	286	328
	A1	11	mm	108	123	146	160	204	230	269	302	336	382
	B		mm	102	123	147	166	192	224	244	273	303	340
	D		mm	59	70	84	97	112	126	151	166	182	213
	E		mm	45	50	59	64	85	95	110	125	140	160
	E1*		mm	43	47,5	56	60,5	80	89,5	104,8	118	132,5	153,5
	G	11	mm	3	3	4	4	4	4	6	6	6	8
	G1*		mm	7	8	10	11	14	15	16,5	20	21	21
	H		mm	6,5	7	9	10	13	14	15,5	19	20	20
	S		mm	46	43	54	46	76	88	98	117	135	167

* E1 and G1 are min. dimensions to allow disc-pack disassembly without moving the machines.

escodisc

DMUFR 38-45 ⇨ 160-185



 ← A105			Type DMUFR											
			38-45	45-55	55-65	65-75	75-90	85-105	95-105	110-120	125-135	140-160	160-185	
	1	mm	Ø max.	45	55	65	75	90	105	105	120	135	160	185
			Ø min.	0	0	0	25	32	38	45	55	65	65	80
	2.1	Nm	Tn	190	330	750	1330	2200	3500	5600	8000	10900	14200	19800
			Tp	290	500	1120	2000	3320	5200	8400	12000	16400	21200	29600
	3	tr/min omw/min rpm min ⁻¹	min.max.	8000	6800	6000	5000	4300	3600	3200	2800	2500	2300	2000
				16000*	13600*	12000*	10000*	8600*	7200*	6400*	5600*	5000*	4600*	4000*
	12	degré graad degree Grad	ΔK _w	0,75	0,5	0,5	0,5	0,5	0,5	0,5	0,5	0,5	0,5	0,5
			ΔK _a	1,2	1	1,2	1,3	1,5	2	2	2,2	2,6	3,3	3,4
	12	mm: ±	ΔK _r	0	0	0	0	0	0	0	0	0	0	0
			S	0	0	0	0	0	0	0	0	0	0	0
	4	kgm ²	J (WR ²)	0,001	0,003	0,007	0,015	0,032	0,0683	0,1095	0,2035	0,3493	0,601	1,136
				1,91	3,23	5,31	8,3	13,15	21,13	26,21	38,94	54,3	77,35	113,6
mm ±	A	11	mm	76,7	96,5	107	129	150	183	204	235,5	269	300	340
	B		mm	88	102	123	147	166	192	224	244	273	303	340
	D		mm	58,5	69,5	82	97,5	113	132	133	154	175	196	228
	E		mm	35	45	50	60	70	85	95	110	125	140	160
	H		mm	6,7	6,5	7	9	10	13	14	15,5	19	20	20

* Balancing needed